

FPI 700



Table of Contents

1	Read this First	1
	Safety.....	1
	Declaration of Conformity (EU only).....	1
	About this manual.....	1
2	Meet your Document System	3
	Introduction.....	3
	Operating Controls.....	5
	Control Panel.....	6
	Power Up.....	7
	Home screen.....	8
	What is a Job?.....	8
	Job overview.....	9
	Settings menu.....	10
	Remote assistance (optional).....	10
	Tri-Fold option.....	11
	Shut Down the System.....	12
3	Working with Jobs	13
	Introduction.....	13
	Use an existing job.....	13
	Create a New Job.....	14
	Job Settings.....	15
	Save a Job.....	18
	Run a Job.....	19
	A Daily Mail job.....	20
	A Tri-Fold job.....	21
4	Loading the System	24
	Installing the Envelope Catch Tray.....	24

Document Orientation.....	25
Document Feed Trays.....	26
Loading Envelopes.....	29
Filling the Sealing Liquid Reservoir.....	31
5 Settings menu	32
Open the Settings Menu.....	32
Open the Supervisor menu.....	33
Supervisor Settings Menu.....	35
6 Operator Maintenance	41
Maintenance.....	41
Cleaning or Replacing Moistening Brushes.....	42
Clean the system.....	42
7 Fault finding	43
Fault Finding.....	43
Clearing Stoppages.....	44
Operator Troubleshooting.....	46
8 Specifications	53
Technical Specifications.....	53
Dimensions and weight.....	54
Hopper and Feeder Capacity.....	54
Document Specifications.....	55
Envelope and Insert Specifications.....	56
9 Terminology	58
Terminology description.....	58

1 Read this First

Safety



Ensure you have read and fully understood the safety requirements in the [Safety Guide](#).

Declaration of Conformity (EU only)

The product presented in this guide meets the requirements of applicable directives. For more details refer to the Declaration of Conformity. Contact your authorized distributor for availability of this document.





About this manual

Disclaimer

This Guide is published without any warranty. Improvements and changes to the online Guide necessitated by typographical errors, inaccuracies of current information, or improvements to programs and/or equipment, may be made at any time and without notice. Such changes will, however, be incorporated into new editions of the PDF Guide (if applicable).

Symbols

This manual uses the symbols listed below.

This symbol...	Indicates...
	WARNING: Indicates a human safety hazard.
	ATTENTION: A risk to the equipment or mail could result from an action you may perform.
	NOTE: A remark that explains different cases or specificities.
	TIP: Advice to help save you time when processing your mail.
	SUPERVISOR: Indicates that you have to use the supervisor menu to perform the procedure.

Languages

In the EU the user guide must be available in the national language(s) of the country where the system is delivered. Therefore, if the User Guide is not available in your country's language(s), contact your authorized distributor.

2 Meet your Document System

Introduction

The system feeds, folds and inserts documents into envelopes and then seals and stacks the envelopes. Automatic monitoring ensures the correct number of inserts per envelope.

The system is a sophisticated folding and inserting system which can process large quantities of mail rapidly and easily.

You can save the settings of the system (document type, envelope type and fold type) in so-called jobs.

2

English

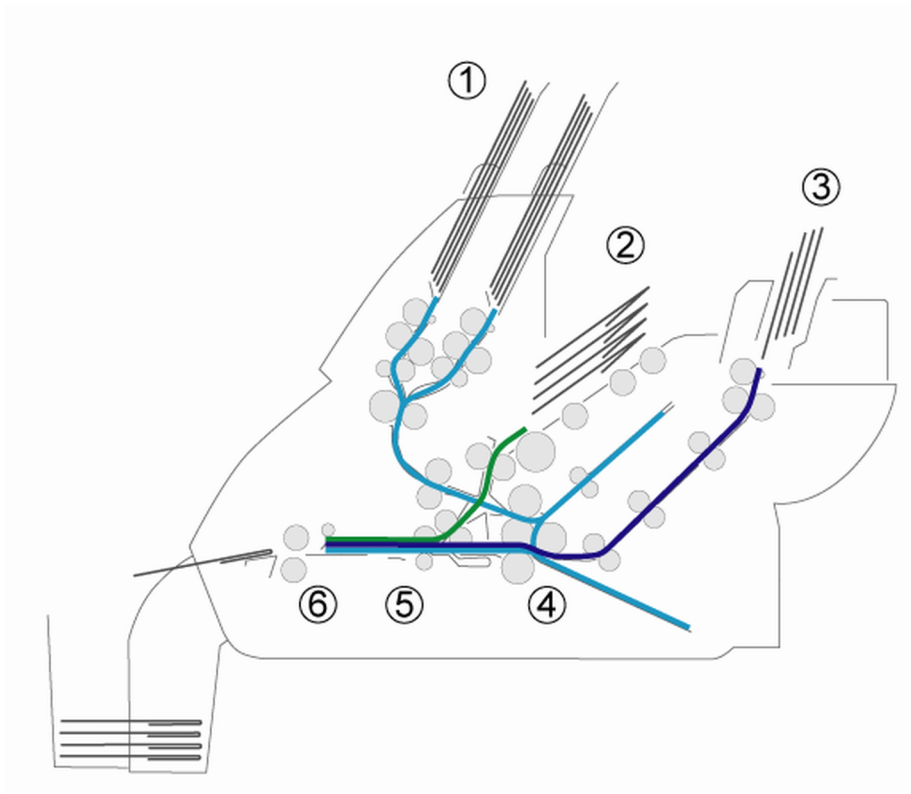

The figure shows an overview of the systems document and envelope flow.

Feeder Area (1)

The system has a feeder block with two document feeders. The feeder block is equipped with feeder swap. This means that you can link both feeders as pairs. When the first feeder is empty, the system switches to the other feeder. Meanwhile you can refill the other empty feeder without stopping the system. The front feeder (feeder 1) is equipped with a “daily mail” function to process documents or sets of documents which cannot be processed automatically (e.g. stapled).

Double Feed Control (DFC)

Each feeder has double feed control (DFC). In this way the system can detect faulty sets of documents. When a job is started, the first document taken per feeder is used for a reference measurement. When a document is exceeding that reference thickness an error will be displayed.



When Daily mail is selected, the DFC is switched off automatically.

Envelope Hopper (2)

The envelopes are picked up and transported to the insert position inside the system.

Feeder for Business Reply Envelopes (BRE) and Other Enclosures (3)

Small enclosures or BREs are fed from feeder 3 and added to the folded document set.

Folding area (4)

In the folding area the documents are folded. The following fold types are possible (see “Terminology” on page 29):

- No fold
- V-fold (single fold)
- C-fold (letter fold)
- Double V-fold (double parallel fold)

Inserter (5)

The folded document set is transported to the inserter unit and inserted into a waiting envelope. The inserter can seal the envelope.

Exit (6)

The mail set leaves the system from the exit.

Operating Controls

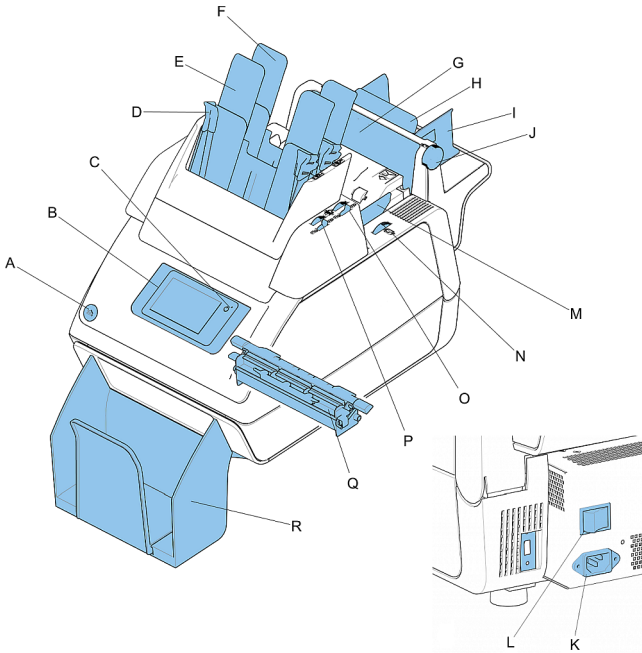

A	button to open the system	J	thumb wheel to adjust side guides feeder 3
B	control panel with touch screen	K	power inlet
C	On/Off button	L	power switch
D	paper guides	M	side guides envelope hopper
E	document feeder 1	N	thumb wheel for adjusting side guides envelope hopper
F	document feeder 2	O	locking levers for side guides (document feeder trays)
G	flap, for access to document path of feeder 3	P	thumb wheels for adjusting side guides (document feeder trays)
H	support feeder 3	Q	sealing liquid reservoir
I	side guides feeder 3	R	catch tray

Control Panel

2

English



On/Off (B): The touch sensitive button in the upper right corner of the display switches the system on or off. If after operation the system is not used for 15 minutes, the system switches to sleep mode. If you touch the screen the system will switch to operation mode again. If the system is not used for one hour, the system switches off to safe power.

Status LED (C): A status LED indicates the state of the machine: a green LED indicates that the system is switched on. An orange LED (and a black screen) indicates that the system is in sleep mode. No colored LED (together with a black screen) indicates that the system is switched off.



The display is a capacitive touch screen. To avoid permanent damage of the display, do not use sharp objects to operate the display.



To clean the display use a dry lint-free or microfiber cloth. If water is necessary to clean the screen, you should make your microfiber cloth slightly damp instead of putting the water directly on your screen. Never use large amounts of water, harsh chemicals, abrasive cloths or paper towels to clean the display.

Power Up

To start up the system:

1. Connect the system to the mains power supply.



You can severely damage the machine if it is connected to the incorrect mains voltage. Before plugging in the machine, check if the local voltage is the same as the voltage mentioned on the type plate.

2. Use the power switch to switch on the system. The power switch is located at the back of the system.
3. Press the on/off button next to the display.



The touch screen shows the "Home screen".

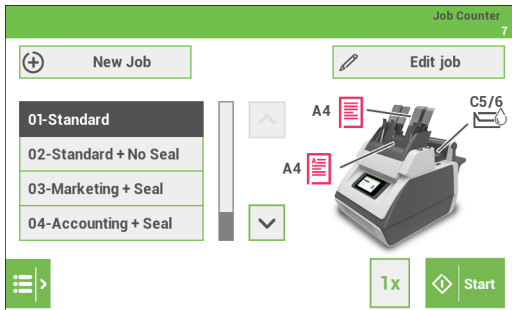

Home screen

2

English

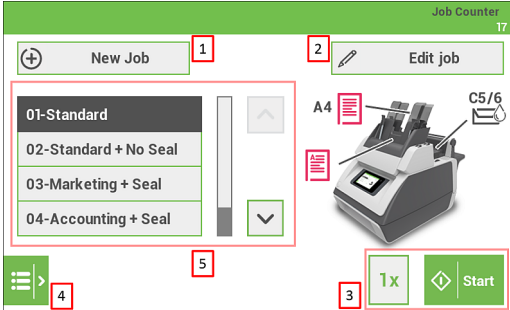

When you start up the system, the 'Home screen' appears. The LH side of the screen shows the job list. The RH side of the screen shows the selected/current job. Other things you can do here are:

1. Create a new job
2. Edit the selected/current job
3. Start the selected/current job
4. Open the settings menu bar *)
5. Select another job

*) From the settings menu bar you can get access to the following:

- the "main" settings menu
- the Remote Assistance screen

What is a Job?

If you have to process a lot of mail sets of the same type (for example bills), you can save the settings to a 'job'. The next time you just select the job and immediately start without defining any settings.

The following settings are saved in a job:

- Envelope type/size;
- Sealing on/off;
- Which document feeders should be used, how many documents should be fed from each feeder and document height for each feeder;
- Feeder linking on/off;
- If BREs or insert cards should be included;
- Address position;
- Double feed control settings;

Job overview

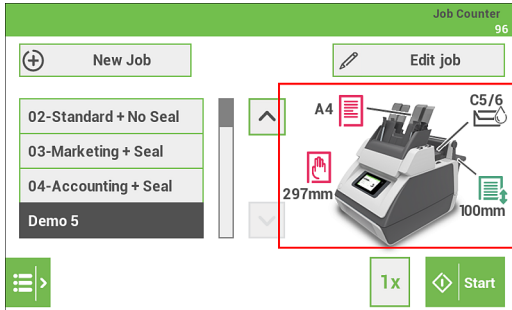

The job overview of the selected/current job is part of the 'home screen' and shown on the RH side.

This job overview shows the following information of the selected job:

- A picture of the system with symbols for the selected features. The following symbols can be used:

	Feeder is set for daily mail
	Envelope size and whether sealing is on/off
	Document size and if the document has to be fed face up/down
	BRE size

As part of the home screen also the Job Counter is shown of the selected job. The Job counter shows the total number of mail sets that have been processed with this job.

The counter settings are job related.

Settings menu

2

English

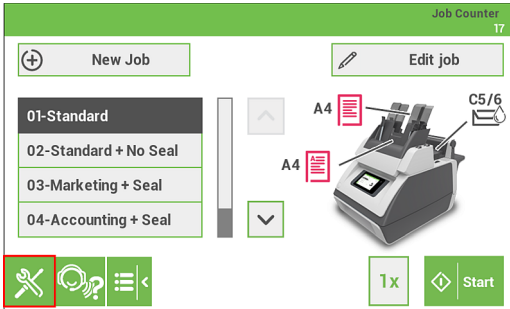

When you open the settings menu bar, tap on the **[Settings]** symbol button to open the "Settings menu". This Settings menu shows the following possibilities:

- **Language settings:** change the language of the user interface.
- **Supervisor Settings menu:** For authorized personnel only. Via this menu it is a.o. possible to customize the envelope height, adjust the stop position etc. (see "[Open the Supervisor menu](#)" on page 33" for more information).
- **Key click:** if you tap this button you can choose if you want to turn the key click sound on or off.

Remote assistance (optional)



Ask your authorized distributor if this feature is available for your system/organization.



It is necessary that the system is connected to the internet.

(Online) Remote Assistance is a tool for help desk guidance. Add the support key supplied by the support assistant and follow the instructions as indicated by the support assistant. The remote assistance screen can be entered by tapping the second symbol in the settings bar.

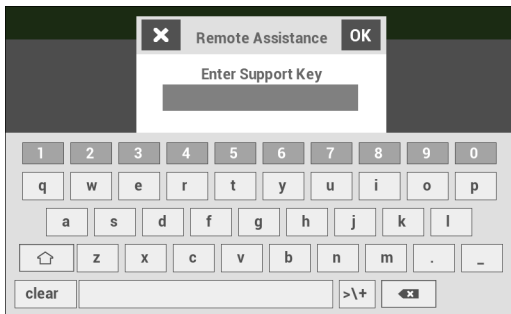
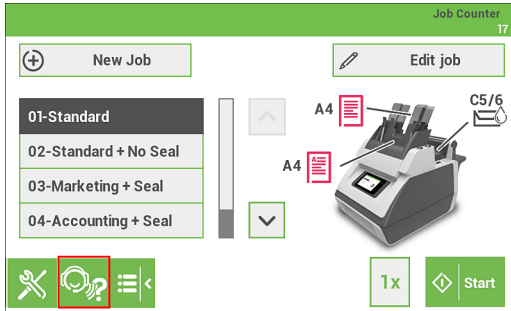

Tri-Fold option

Some applications require a fold setting where all three “panels” have the same dimensions, the so called “Perfect Fold”. In order to have those documents correctly transported to the exit an extra pair of transportation rollers have to be fitted in the system. By replacing the sealing liquid reservoir with the “Tri-Fold” transportation unit correct transportation to the exit is ensured.



Using the Tri-Fold option is only possible if this option has been set by the Service organization.

Shut Down the System

1. Press the **[On/Off]** button. The system completes and inserts the current set and stops, this results in a cleared system. After that the system switches off.



In case the system is unresponsive or fails to switch off, press and hold the touch sensitive power button for 10 seconds to switch off the system.

2. Press the Power switch to shut down the system.
-

3 Working with Jobs

Introduction

With the system you can process mail sets in the following ways:

- **Using an existing (saved) job:** Existing jobs are shown in the Job list. These jobs have been saved via the job creation process.
- **Using a new, unsaved job:** after tapping the **[New Job]** button and finishing the Job Wizard just tap the start button. It is not needed to save the job first.

Use an existing job



Before you use an existing job where sealing is required, make sure the sealing liquid reservoir is filled.

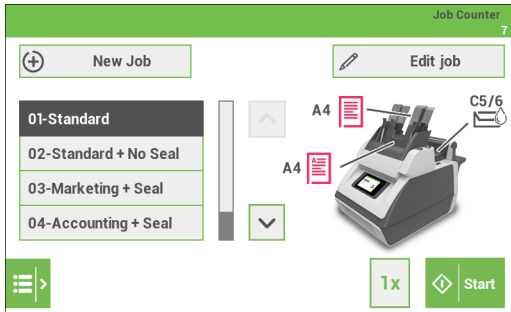

To use an existing job:

1. From the home screen choose a job. The job information appears, see "[Job overview](#) on page 9".
2. Load envelopes as specified in the job.
3. Load the documents face up and trailing, as specified in the job. Place the address carrier in feeder 1.
4. Tap the **[1x]** button to start a test run or tap the **[Start]** button to start the job. If you tap the **[1x]** button, the system helps you to adjust the address position (see "[Address Position](#)" on page 20).

Create a New Job

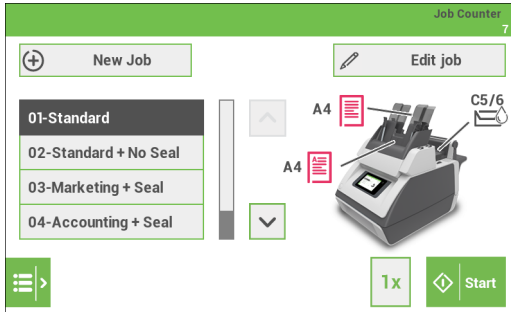

To create a new job:

1. In the home screen, tap [**New job**]. The New job Wizard starts and helps you to choose;
 - Envelope type (size). Custom is only available if defined by the supervisor (see “[Supervisor Menu](#) on page 33”).
 - Closing type; if the envelopes should be sealed or not.
 - Document size for feeder 1.
 - Feeding type: Automatic feeding or Daily mail (manual).
 - Document size for feeder 2. If you choose None, you can use feeder 2 as a linked feeder. This means that when one feeder is empty, the system automatically starts picking documents from the other feeder.
 - Enclosure type (size) from feeder 3.
 - Fold type.
2. Tap the [**1x**] button to make sure that the address position is correct (see “[Address Position](#) on page 20”).
3. Tap the [**Start**] button to start the job or tap the [**Save**] (disk symbol) button to save the job.
4. If you tap the [**Save**] button:
 - Enter a name for the job. Use the backspace button to clear a character left of the cursor position.
 - Tap [**OK**] to confirm the job name.

Job Settings

Job Settings menu

When you tap in the Home screen on the **[Edit job]** button, the "Job Settings" menu opens. This menu enables you to:

- Edit a job (see ["Edit a Job"](#) on page 15).
- Delete a job (see ["Delete a Job"](#) on page 16).
- Reset the job counter: sets the counter to zero (see ["Reset job counter"](#) on page 16").
- Switch per feeder the double feed control (DFC) on or off (see ["Feeder options"](#) on page 17").

Edit a Job

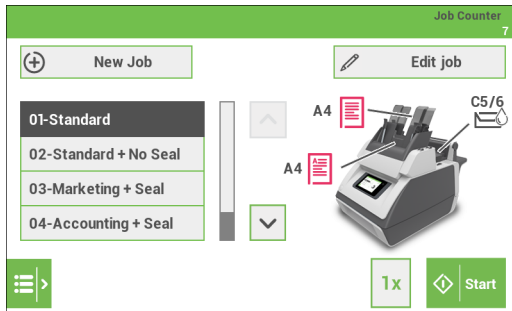

To edit an existing job:

1. From the home screen choose a job.
2. Tap the **[Edit job]** button. The "Job Settings" menu opens.

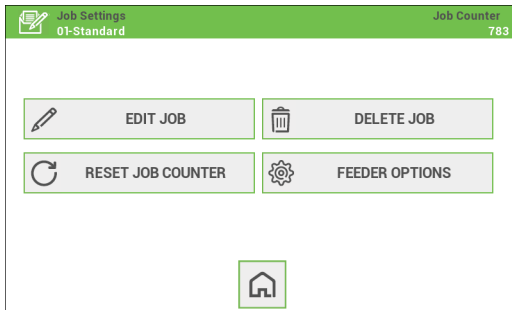

3. In the "Job settings" menu tap the **[Edit job]** button. The Job Wizard starts and helps you to change job settings.

4. Tap **[Save]** to save the job with the changed settings.
5. Press the **[1x]** button to make sure that the address position is correct (see "Address Position").

Delete a Job

To delete an existing job:

1. From the home screen choose a job.
2. Tap the **[Edit job]** button. The "Job Settings" menu opens.
3. Tap **[Delete job]**.

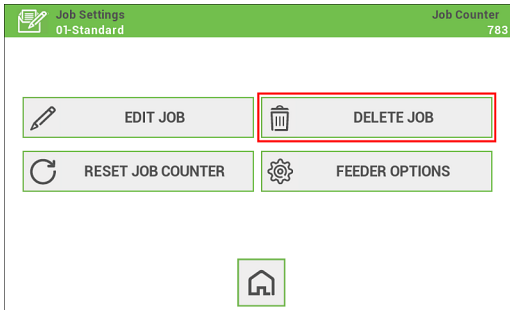

4. Tap **[Yes]** to confirm. The job will be deleted without a warning.

Reset the job counter



Counter settings are job related.

The job counter shows the total number of mail sets that have been processed with the selected job. If you want to set the job counter of the job to zero proceed as follows:

1. From the home screen tap the **[Edit job]** button. The "Job Settings" menu opens.

- In the "Job Settings" screen tap the [**Reset job counter**] button.

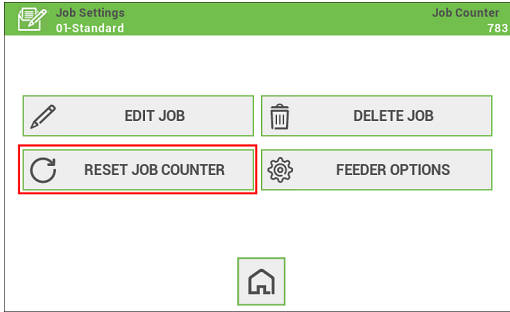

- You will be asked if you want to reset the job counter. Tap [**Yes**] to reset the job counter.

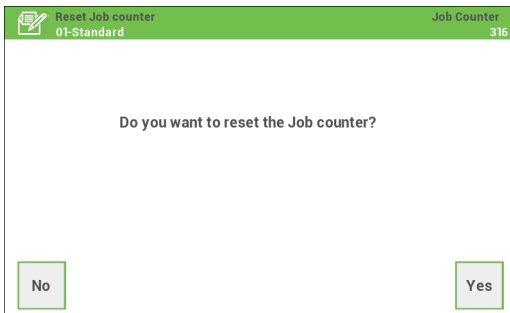

- The job counter will be reset to zero. The "Job Settings" screens appears again.

Feeder options

For some applications it is preferred to switch the double feed control (DFC) off per feeder. For example, if you have a document with an address sticker on it, the DFC may see the sticker as a double feed; an error message will be generated. To prevent this you can switch the DFC off per feeder. Proceed as follows:

- From the home screen tap the [**Edit job**] button. The "Job Settings" menu opens.

2. Tap the **[Feeder options]** button.

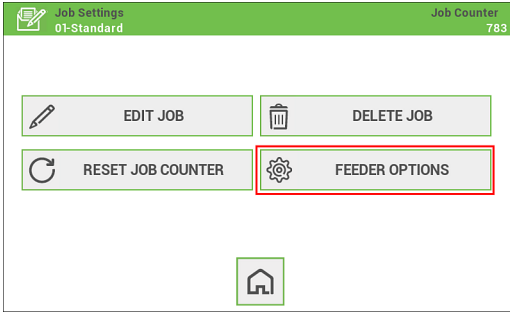

3. Select per feeder if you want to have the double feed control switched on or off.

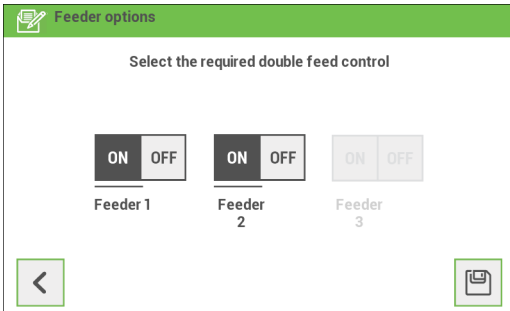

4. Tap the **[Disk]** button to save the settings.

Save a Job

When you have created a new job or edited a job, save the job as follows:

1. After you have completed the job definition, tap the **[Save]** button.
2. Enter the job name.

Note: It is possible to delete the existing name at once by using the **[clear]** button.

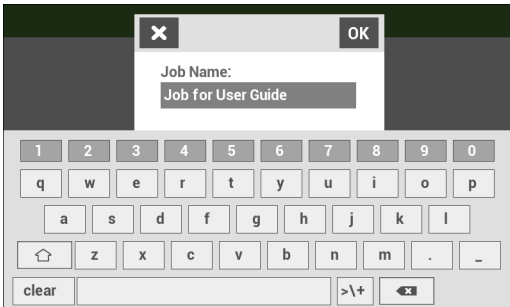

3. Tap [OK] to save the job.

The job is added to the job list.

Run a Job



Before you run a job where sealing is required, make sure the sealing liquid reservoir is filled.

1. From the home menu choose a job. The job information appears (see “[Job Overview](#) on page 9”).
2. Load envelopes as specified in the job.
3. Load the documents face up and trailing, as specified in the job. Place the address carrier in feeder 1.
4. Tap the [1x] button to start a test run. If you tap the [1x] button, the system helps you to adjust the address position (see “[Address Position](#)” on page 20).

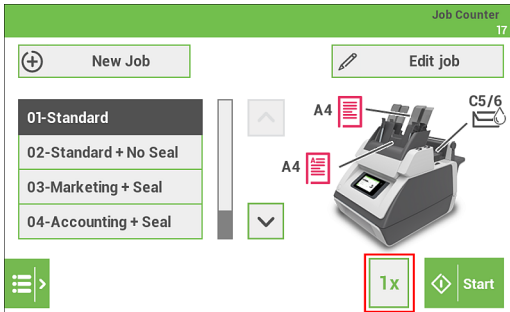

5. Tap the [Start] button to start the run. The system starts processing your mail sets.
6. Tap the [Stop] button to stop the run. The system completes and inserts the current set and stops. This results in a cleared system which is ready to process a new job.



Address position

The address on the document set should be positioned in a way that you can read it from the envelope window. If it is not readable, adjust the address position as follows:

1. Choose a job and tap the [1x] button.
2. Use the arrow buttons up/down to adjust the address position.

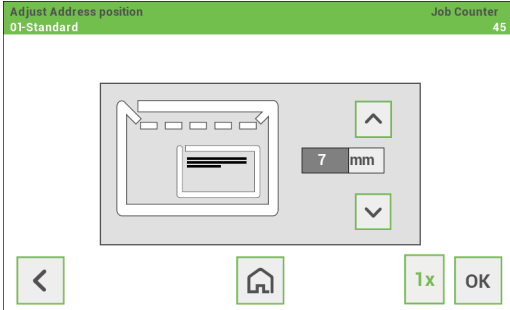

3. Tap the [1x] button again to verify the new position.
4. Repeat step 2 and 3 until the address is clearly visible in the envelope window.
5. Tap the [OK] button if the position is correct.

A Daily Mail job

To process documents or sets of documents, which can not be processed automatically (e.g. stapled documents), you can use feeder 1 as a daily mail feeder. Daily mail can handle sets with a maximum of five sheets (80 g/m2).

1. To use the daily mail function, define a new job with daily mail (see “[Create a new Job](#) on page 14”) or use an existing daily mail job.
2. Place the document or document set in the feeder 1.

- Tap the [**1x**] button to start a test run. If you tap the [**1x**] button, the system helps you to adjust the address position (see "Address Position" on page 20).

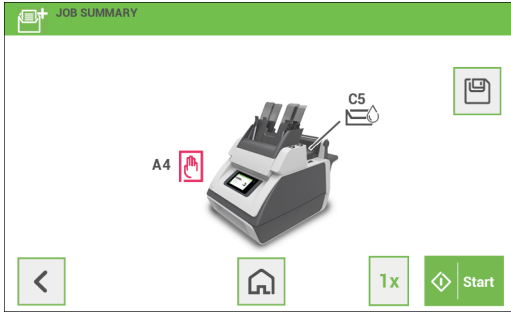

- Tap the [**Start**] button to start the job. The document or document set will be folded and inserted into the envelope as defined in the selected job.
- Place the next document or document set in the feeder. The system will keep running to process the inserted document or document set.
- When finished with Daily Mail, press the [**Stop**] button to stop the job.

A Tri-Fold job



Sealing is not possible when using the Tri-Fold option.

For applications where it is required to use a letter fold where all three panels have the same dimension the Tri-Fold transportation unit has to be installed. Proceed as follows to replace the sealing liquid reservoir by the Tri-Fold transportation unit:

- Press the  button to open the system (see "Operating Controls").

2. Remove the sealing liquid reservoir with the blue handles **A** carefully out of the system.

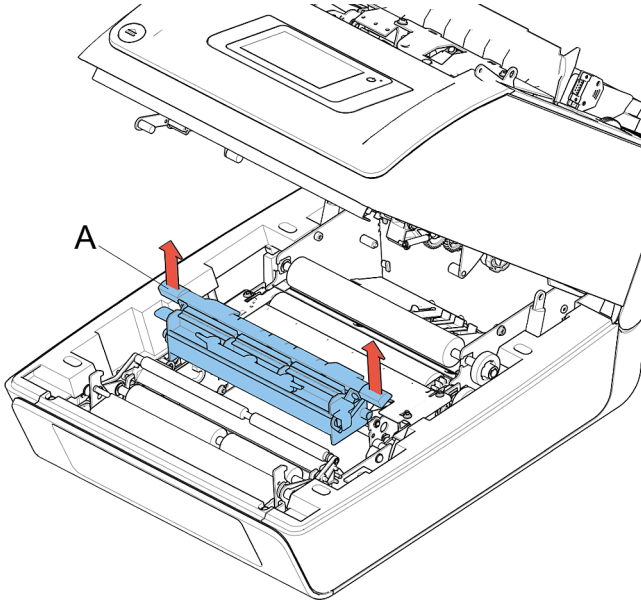

3. Place the Tri-Fold transportation unit into the system in exact the same way as when placing the sealing liquid reservoir.

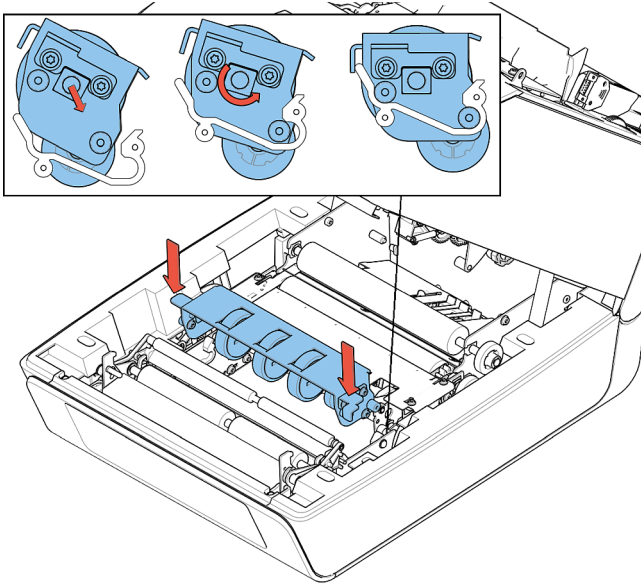

4. Choose a job that has been programmed for the Tri-Fold option or program a new job in which the Tri-Fold option has been selected.

5. Run the job.

4 Loading the System

Installing the Envelope Catch Tray

To install the envelope catch tray:

1. Move the catch tray until the clamps hold the feet of the system.

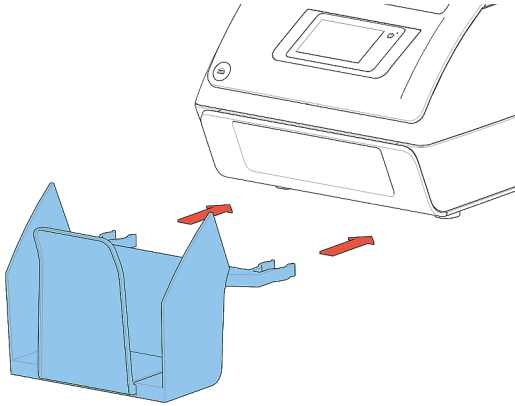

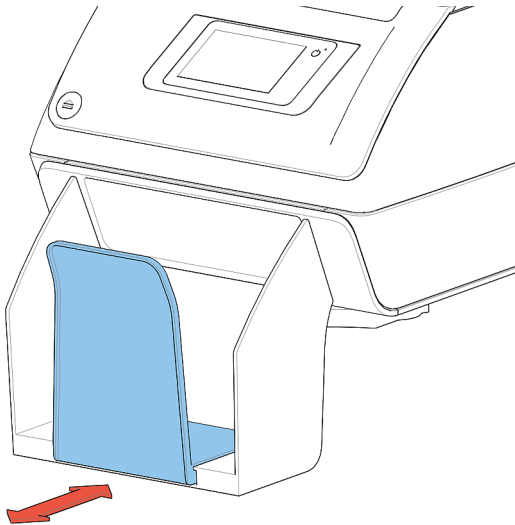

2. Adjust the catch tray to the correct envelope size.



Document Orientation

The touch screen shows how to load documents and envelopes into the feeders. The table shows the meaning of the symbols:

	Address carrier face up and trailing (top address)
	Enclosure face up

Document Feed Trays

Adjusting the Side Guides of the Document Feeder

To adjust the side guides of the document feeder trays:

1. Pull lever **C**.

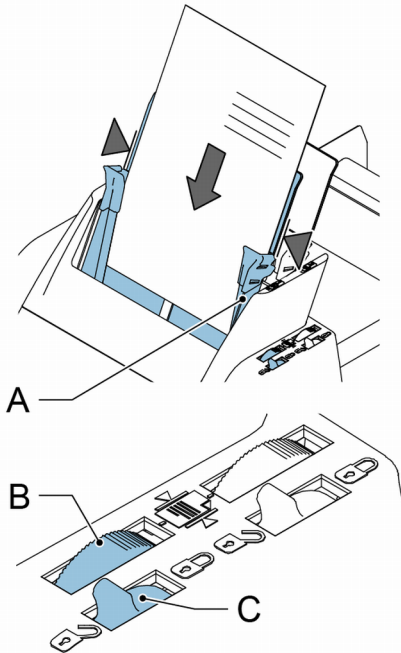

2. Move the side guides **A** apart as far as possible with thumb wheel **B**.
 3. Put a small stack of documents between the side guides.
 4. Move the side guides towards the documents with thumb wheel **B**. The space between the side guides and the documents should be such that the documents have just enough play to move freely.
 5. Return lever **C** to its original position.
 6. Remove the stack of documents.
-

Loading the Document Feeder Tray

To load the document feeder tray:

1. Pull lever **C**.

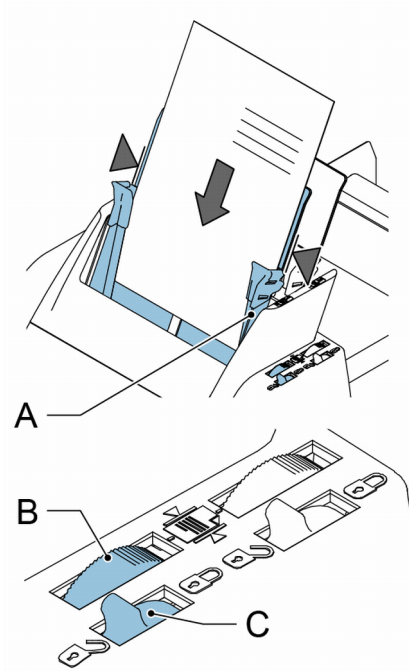

2. Place a stack of documents between the side guides. Feed the documents (depending on the type of documents) as shown in "[Document Orientation](#)".
 3. Return lever **C** to its original position.
-

Adjusting the Side Guides of Feeder 3

To adjust the side guides of feeder 3:

1. Move the side guides **C** apart as far as possible with thumb wheel **D**.

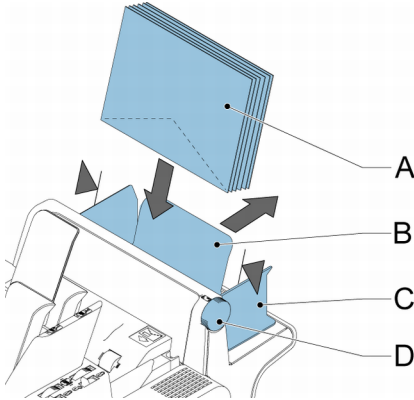

2. Pull back support **B**.
3. Put a small stack of enclosures **A** between the side guides.
4. Release support **B**.
5. Move the side guides towards the enclosures with thumb wheel **D**. The space between the side guides and the enclosures should be such that the enclosures have just enough play to move freely.
6. Remove the stack of enclosures.

Loading Feeder 3

To load feeder 3:

1. Pull back support **B**.

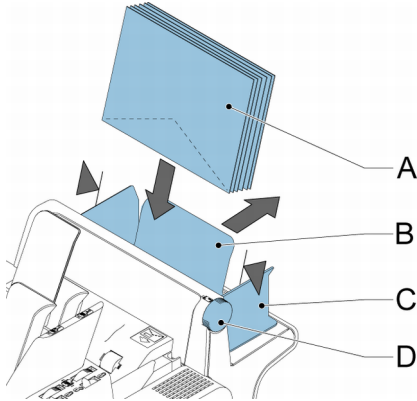

2. Place a stack of documents or BREs between the side guides. Place documents with trailing edge down. Place BREs with leading edge down and the flap at the support side.
3. Release support **B**.

Loading Envelopes



If the distance between the side guides is too large, the envelopes will skew, when transported into the system.

To load the envelopes:

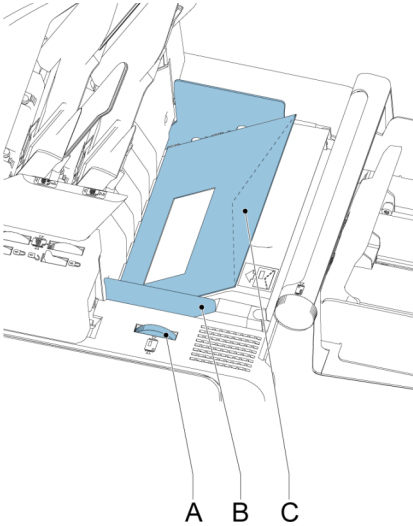

1. Move the side guides **B** apart as far as possible with thumb wheel **A**.
2. Place an envelope **C** in the envelope hopper flap down and trailing (bottom side of envelope pointing to the system).
3. Fan a stack of envelopes and place them, also flap down and trailing, between the side guides on top of the first envelope.

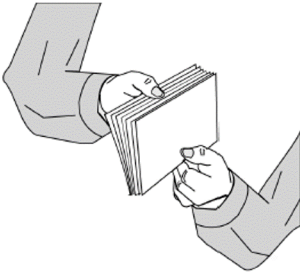

4. Move the side guides towards the envelopes with thumb wheel **A**. The space between the side guides and the envelopes should be such that the envelopes have just enough play to move freely.
-

Filling the Sealing Liquid Reservoir

When you want to seal envelopes, the sealing liquid reservoir must be filled.

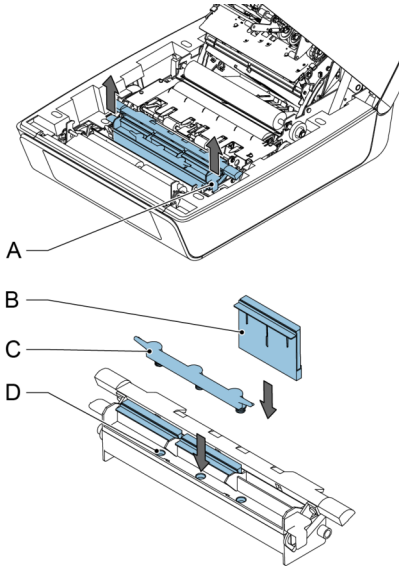

1. Press the  button to open the system (see “Operating Controls”).
2. Lift the sealing liquid reservoir **D** with the blue handles **A** carefully out of the system.
3. Remove the strip **C** from the reservoir.
4. Fill the three reservoirs with sealing liquid.
5. Make sure the brushes **B** are moistened sufficiently.
6. Replace the liquid reservoir.
7. Close the system.

Before you start the job, wait approximately 5 minutes for the brushes to moisten.

5 Settings menu

Open the Settings Menu

In the settings menu for the operator it is possible to set the language. It is also possible to open the Supervisor menu (locked with a PIN code).

If you want to view or edit any of the Operator Settings:

1. From the home screen open the settings menu bar and tap the **[Settings]** symbol.

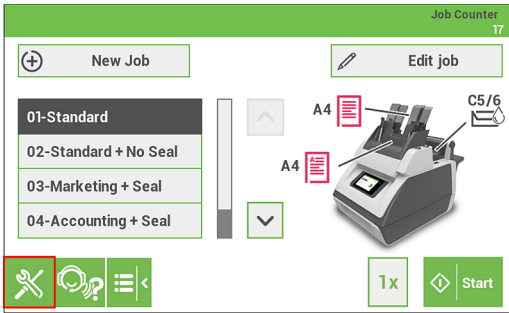

2. Tap **[Language settings]** if you want to change the language of the User Interface. Save the setting by tapping the disk symbol button.

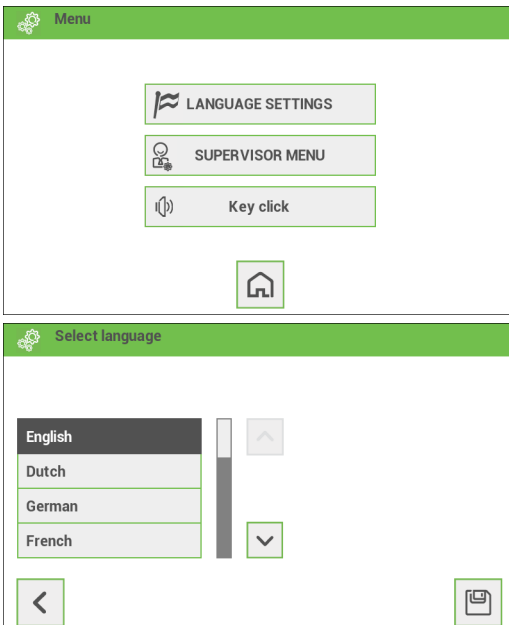

3. Tap **[Supervisor menu]** to open the login screen for accessing the Supervisor menu.

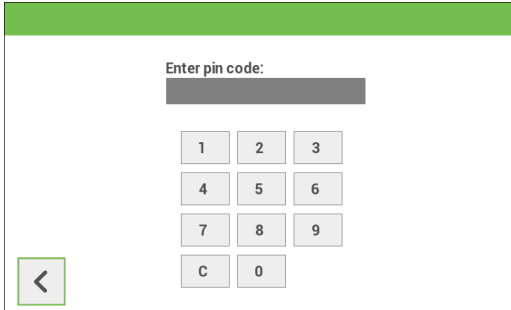

4. Tap **[Key click]** to open the "Key click" setting screen. Tap "On" to switch the key click sound on or tap "Off" to switch the key click sound off. Save the setting by tapping the disk symbol button.

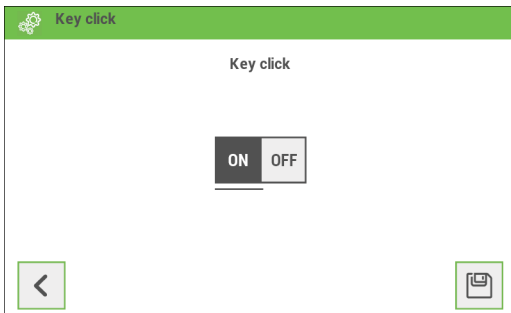

For more information regarding the Supervisor menu refer to "[Open the Supervisor menu](#) on page 33".

Open the Supervisor menu

In the Supervisor menu it is possible to do the following:

- customize the envelope height, see "[Custom Envelope](#) on page 35";
- adjust the stop position, see "[Adjust stop position](#) on page 36";
- adjust the moistening position, see "[Adjust moistening position](#) on page 37";
- edit the WiFi settings, see "[WiFi Settings](#) on page 37";
- calibrate FE1/2 clutches, see "[Calibrate FE1/2 clutches](#) on page 39";
- edit PopUp options, see "[PopUp options](#) on page 39";
- view Versions, see "[Versions](#) on page 40".

If you want to view or edit any of the Supervisor settings proceed as follows:

1. From the home screen open the settings menu bar and tap the **[Settings]** symbol.

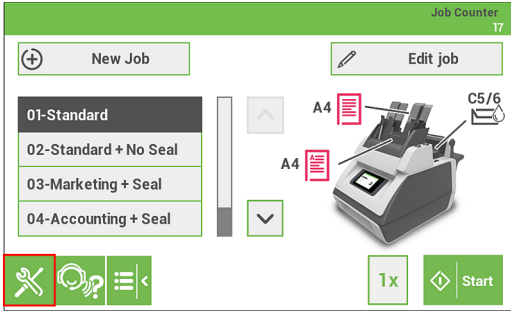

5

English

2. Tap **[Supervisor menu]** to open the login screen.

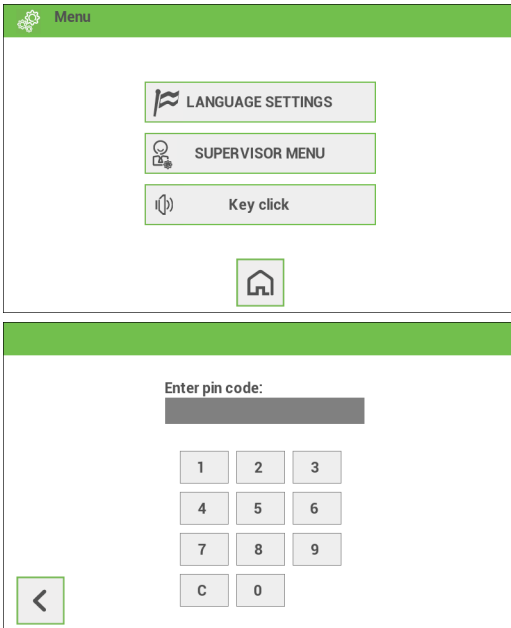

3. Login as Supervisor with pin code **2546**.

4. Tap the relevant button to edit or change the settings.

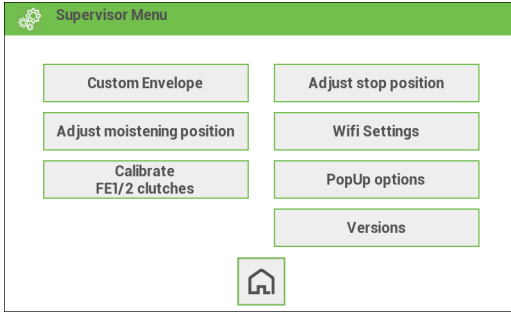

Supervisor Settings Menu

Customize the envelope height

It is possible to customize the height of the envelope if the default envelope height settings do not meet the specification of the envelope. To customize the height:

1. Go to the supervisor menu.
2. Tap [**Custom Envelope**].
3. Set the correct envelope height using the up/down arrows.

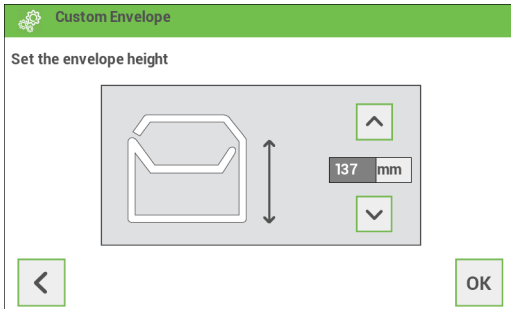

4. Tap the [**OK**] button.
-

Envelope Position

To make a good insert of the document set into the envelope, the envelope should be positioned correctly.

To verify the envelope position:

1. Go to the supervisor menu.
2. Tap **[Adjust stop position]**.
3. Choose the envelope type to setup and tap the arrow button.

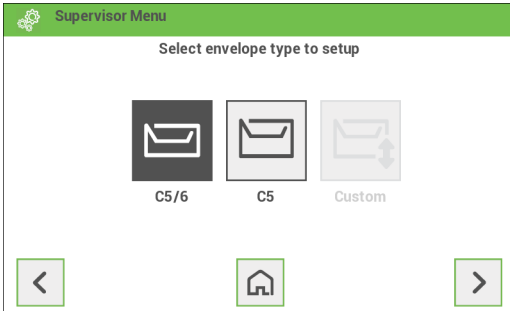

4. Tap the **[1x]** button. Make sure that the document set is completely inserted into the envelope.

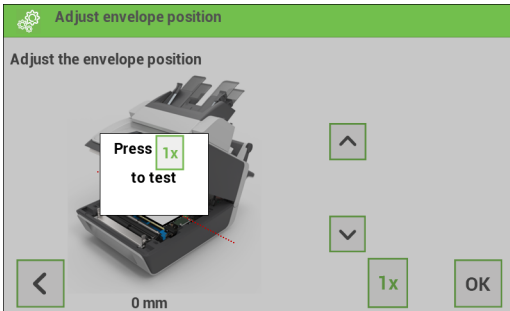

5. If not, use the arrow buttons up/down to adjust the envelope position.
6. Repeat step 4 and 5 until the envelope position is correct.
7. Tap the **[OK]** button.

Moistening position

If the moistening area of the envelope is not correctly moistened, adjust the moistening position as follows:

1. Go to the supervisor menu.
2. Tap **[Adjust moistening position]**.
3. Choose the envelope type to setup and tap the arrow button.
4. Use the arrow buttons up/down to adjust the moistening position.

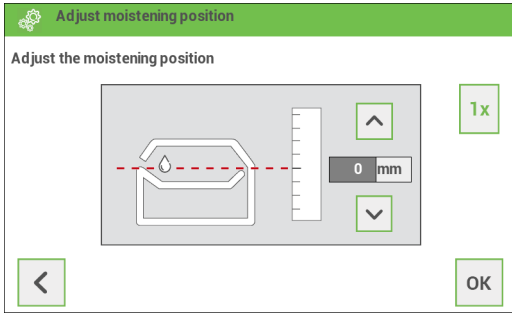

5. Tap the **[1x]** button to test the new position.
6. Repeat step 4 and 5 until the envelope position is correct.
7. Tap the **[OK]** button if the position is correct.

WiFi Settings

Proceed as follows if you want to connect the system to an available WiFi network:

1. Go to the supervisor menu.
2. Tap **[WiFi Settings]**.
3. This screen will be shown if the system is not connected. Tap the "pencil" button to see if WiFi networks are available.

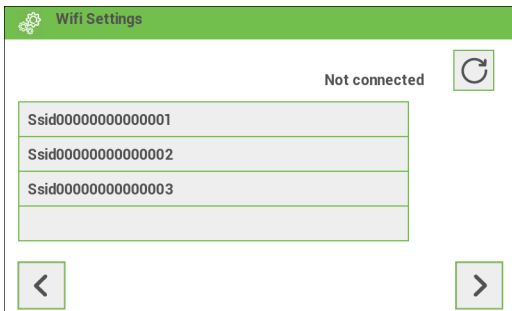

4. Select one of the available WiFi networks and tap the [>] button.

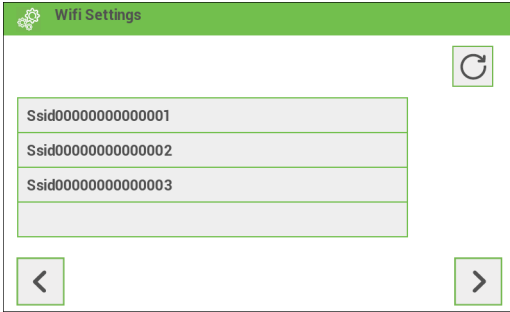

5. Enter the password of the WiFi network and tap "OK".

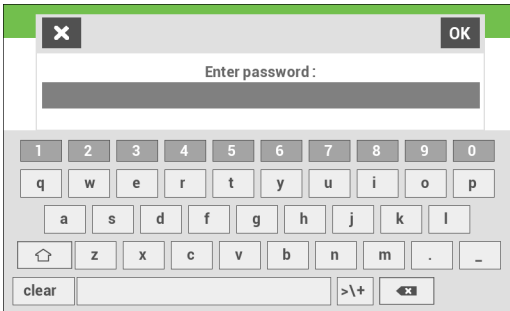

6. Connection with the WiFi network will be established. In the upper left corner of the Home screen a WiFi symbol will appear showing that the system is connected to a WiFi network.

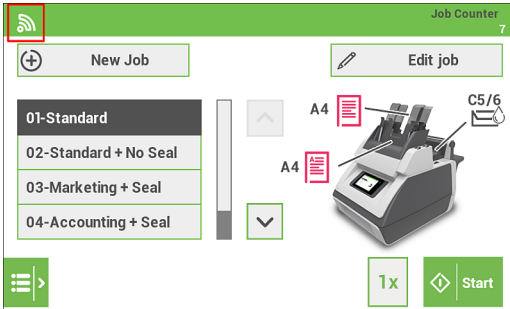

Calibrate FE1/2 clutches

1. Go to the supervisor menu.
2. Tap **[Calibrate FE1/2 clutches]**.
3. Follow the instructions as indicated on the touchscreen.

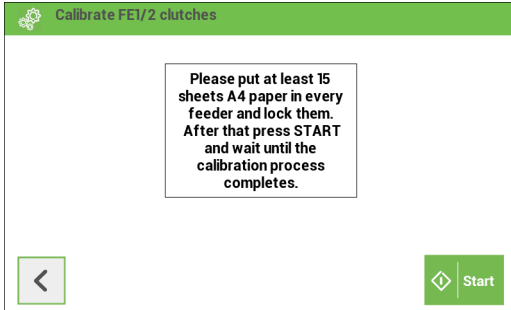

PopUp options

1. Go to the supervisor menu.
2. Tap **[PopUp options]**.
3. Select **[Yes]** if you want the system to show Popup messages. Select **[No]** if you don't want the system to show Popup messages.

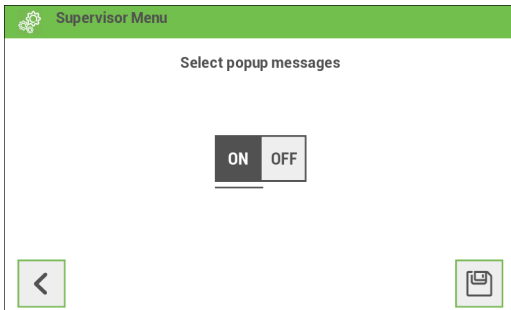

4. Save the setting by tapping the **[disk]** button.
-

Versions

The "Versions" screen shows the serial number of the system and information about the installed software.

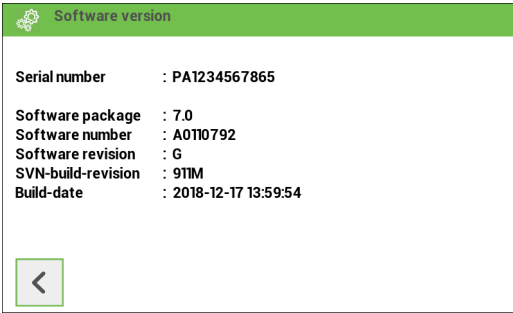

5

English

6 Operator Maintenance

Maintenance



Disconnect the mains power supply before performing any maintenance.

The user must not attempt to service the system beyond that described in this operator manual. All other servicing must be carried out by qualified service personnel only. Please contact your authorized distributor.

Maintenance Frequency	Maintenance
Daily	<ul style="list-style-type: none">• Check the system functions• Keep the system in proper condition by removing dust, paper remains, etc.• When dirty, clean the sealing table and rollers with a slightly wetted cloth, soaked in warm water.
Weekly	<ul style="list-style-type: none">• When dirty or saturated, clean the brushes of the envelope sealing (see Cleaning or Replacing Moistening Brushes).• Clean rollers (see Clean the System).

Cleaning or Replacing Moistening Brushes

See ["Filling the Sealing Liquid Reservoir"](#) on page 31 for the location of the brushes.

1. Open the system.
 2. Lift the sealing liquid reservoir with the blue handles carefully out of the system.
 3. Remove the three brushes.
 4. Clean the brushes with a small amount of water. If the brushes are worn, replace them with new ones.
 5. Install the brushes.
 6. Fill the tray with sealing liquid.
 7. Make sure the brushes are moistened sufficiently.
 8. Replace the liquid reservoir.
 9. Close the system.
-

Clean the system

1. Open the system.
 2. Clean the rollers. Use a cleaning product recommended by your authorized distributor and apply it with a lint-free cloth. Wipe each rubber roller while turning it manually.
 3. Clean the casing of the system with a damp cloth and a slightly soapy solution.
-

7 Fault finding

Fault Finding

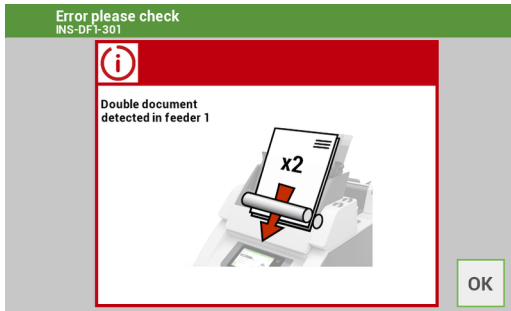

When an error occurs the touch screen shows a screen with the following information:

- An indication of the area in which the error occurred.
- An error description.
- A suggested solution.

Special Errors

- Technical errors. The touch screen shows a message. The error cannot be solved by operating personnel and assistance of the service support is needed.

Warning Screen

When a cover is opened, the touch screen shows a warning screen with the message “Cover open” and a suggested solution “Close cover”.

Clearing Stoppages

Clearing Stoppages

Stoppages can occur in the following area's:

- Document feeders.
- Document path.
- BRE feeder.
- Envelope feeder.

Document Feeders

When a stoppage occurs in the document feeders, remove the documents as follows:

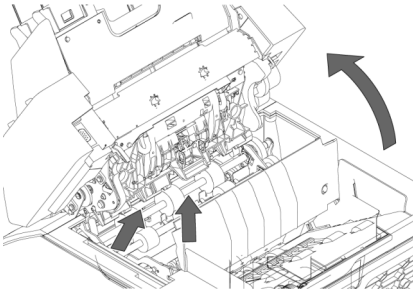

1. Pull the feeder block forward (see figure).
 2. If necessary lift the feeder block out of the system.
 3. Remove the documents from the bottom of the feeders.
 4. Return the feeder block into the system.
-

Document path

When a stoppage occurs somewhere in the document path, remove the documents as follows:

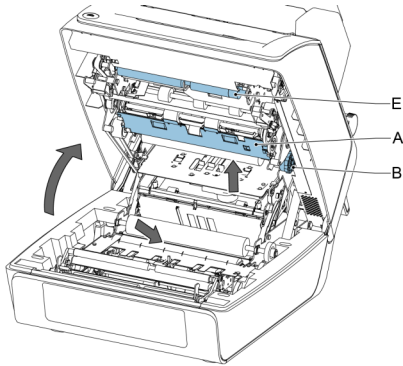

1. Press the  button to open the system.
2. If necessary lift flap [A], or rotate [B] or roller [E] to transport the document.
3. Remove the documents.
4. Close the System.

Feeder 3

When a stoppage occurs in feeder 3, remove the document or envelope as follows:

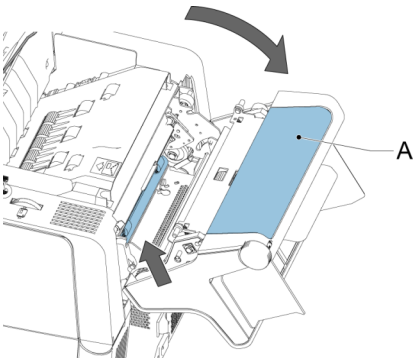

1. Press flap A of feeder 3 and rotate the feeder downward.
2. Remove the document or envelope.
3. Close the feeder.

Envelope Hopper

When a stoppage occurs in the envelope hopper, remove the envelopes as follows:

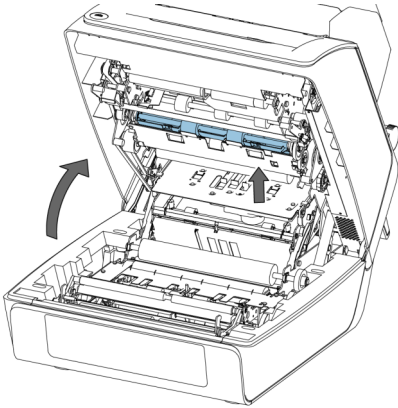

1. Press the  button to open the system.
2. Remove the envelope.

If this is not possible, try to remove it from the top of the hopper:

- Close the system.
- Remove the envelope stack and remove the envelope.

Operator Troubleshooting

Operator Troubleshooting

To resolve problems:

1. Write down the event message number that is shown in the message on the screen.
2. Try to solve the problem by consulting the Troubleshooting Table.
3. Switch the inserter off and on again, to verify system operation.
4. When the error still occurs contact your service organization.



When contacting the service organization, you will also be asked for the last error message and the software package version of the installed software. To determine the software package version, see Software overview.

Startup Problems

Symptom	Possible cause	Remedy	Reference
The system cannot be started after switching on.	System not connected to mains.	Connect the system to the mains.	-
	You switched off the system accidentally.	Switch the system on.	-
	You did not press the power button next to the touch screen.	Press the power button next to the touch screen.	-
	A cover is opened.	Close the covers.	-

Envelope Sealing Problems

Symptom	Possible cause	Remedy	Reference
Envelope not closed properly.	Insufficient moistening.	-	See symptom "Flap not sufficiently moistened."
	The current job has no envelope sealing.	Make sure if the job is programmed to seal envelopes.	"Job Programming"
	Document or enclosure not compliant with job specification.	Make sure the document size and enclosure size equals the job settings.	-
	Documents are not correctly inserted.	Make sure the side guides of the document feeders are in the correct position.	"Adjusting the Side Guides of the Document Feeder".
		Check envelope stop position, adjust if needed.	"Envelope Position"

Envelope contents is wet.	Sealing position is not correctly set.	In the supervisor menu change the settings of the applicable envelope.	“Sealing position”
	Exit roller is wet.	Clean the exit roller.	“Clean the System”
Flap not sufficiently moistened.	Water level low.	Check water level, refill if needed.	“Filling the Sealing Liquid Reservoir”
	Brushes dry.	Check brushes, replace if needed by the extra soaked set.	“Operator Maintenance”
	Brushes dirty.	Check brushes, clean if needed.	“Operator Maintenance”
	Brushes worn out.	Replace brushes.	“Operator Maintenance”
	The current job has no envelope sealing.	Choose job with envelope sealing.	-
	Envelope does not meet the specifications.	Make sure the envelope meets the specifications.	“Envelope and Insert Specifications”
	Poor envelope quality.	Seal an envelope manually to test the adhesion quality.	-
Sealing position is not correctly set.	In the supervisor menu change the envelope settings.	-	

Envelope Feeding Problems

Symptom	Possible cause	Remedy	Reference
Envelopes are double fed.	Envelopes not placed properly in the hopper.	Check and replace if needed.	“Loading Envelopes”
Envelope stops skewed.	Side guides of the envelope hopper are set too wide.	Check side guides and adjust if needed.	“Loading Envelopes”
Envelopes are fed irregularly.	Hopper almost empty.	Refill hopper.	“Loading Envelopes”
	Side guides set too narrow.	Check side guides and adjust if needed.	“Loading Envelopes”
Flap is wrinkled and sometimes not opened.	Envelope not within specifications.	Check specifications and change envelopes if needed.	“Envelope and Insert Specifications”
	Flap sticks.	Store envelopes according to specifications.	“Envelope and Insert Specifications”
	Flap curled.	Envelopes stored or manufactured improperly.	“Envelope and Insert Specifications”

Document feeding Problems

7

English

Symptom	Possible cause	Remedy	Reference
No document fed.	Feeder empty.	Refill feeder.	"Loading the Document Feeder Tray"
	Side guides set too narrow.	Adjust the side guides.	"Adjusting the Side Guides of the Document Feeder"
	Feeder trays are not locked.	Push the lever to lock the feeder.	"Loading Documents"
Skewed documents fed.	Side guides set too wide.	Adjust side guides.	"Adjusting the Side Guides of the Document Feeder"
	Feeder trays are not locked.	Push the lever to lock the feeder.	"Loading Documents"
Shifted documents in feeder trays.	Side guides set too narrow.	Adjust the side guides.	"Adjusting the Side Guides of the Document Feeder"
	Feeder trays are not locked.	Push the lever to lock the feeder.	"Loading Documents"
	Dirty feeder rollers.	Clean the feeder rollers.	
Double documents are fed, but the system does not notice.	Different types of documents fed.	Use daily mail to process different document types.	-
	Documents out of specification.	Check document specifications.	"Document Specifications"

Insert Problems

Symptom	Possible cause	Remedy	Reference
System stops with envelope at insert position (flap not open).	Envelopes stacked reversed in the hopper.	Check envelope feed adjustments. Place envelopes correctly in hopper.	"Loading Envelopes"
	Envelope flap sticks.	Store envelopes according to specifications.	"Envelope and Insert Specifications"
	Wrong envelope type used (not according to specifications or job settings).	Change envelopes according to specifications.	"Envelope and Insert Specifications"
Fingers are placed on top of the envelope.	Envelope stops too early.	Check envelope stop position, adjust if needed.	"Envelope Position"
System stops while inserting (stoppage at the inserting point).	Inserted document too long or not correctly folded.	Make sure the document size and enclosure size equals the job settings.	-
	Envelope throat incorrect.	Check envelope specifications.	"Envelope and Insert Specifications"
	Envelope glued inside.	Eliminate faulty envelopes.	-
	Window not glued properly.	Eliminate faulty envelopes.	-
Envelope not always ejected from sealer.	Inserted document too big.	Make sure the document size and enclosure size equals the job settings.	-
	Document not inserted deep enough.	Check adjustment of envelope stop position.	"Envelope Position"
	Sealing area dirty.	Clean sealing area.	"Operator Maintenance"

Address not readable from window	Address position not correctly defined.	Check address position.	"Address Position"
----------------------------------	---	-------------------------	--------------------

7

English

8 Specifications

Technical Specifications

Model	DS-40i, FPi 700, FD 6104, TSI-2.0s/TSI-2.5s, C400i
Type	Folder and inserter system for small office use.
Theoretical max. speed	1350 inserts per hour, depending on application
Power consumption	100-240 VAC/ 50-60 Hz / 1,3 - 0,6A
Voltage tolerance	100-240 VAC: +6% / -10% 230 VAC: +10% / -10%
Fuse	100/115 Vac: T 5.0 A, 125 V. Time lag, 5.0 Amps. rated current, 125 V. 230 Vac: T 2,5 A H, 250 V. Time lag, 2.5 Amps. rated current, high breaking capacity, 250 V.
Approvals	RED (Radio Equipment Directive) 2014/53/EU FCC Certificate conform 47CFR, part 15 CB Certificate conform IEC 62368-1 UL Listed I.T.E. (Information Technology Equipment), conform UL-IEC 62368-1, file E153801 Conform NEN-EN-IEC 62368-1 and derivatives.
Noise Level	< 65 dBA
Operating temperature	10°C - 40°C (50°F-104°F)
Humidity	30%-80%

Dimensions and weight

	with Catch Tray	without Catch Tray
Height	680 mm (26.8")	540 mm (21.3")
Width	420 mm (16.5")	420 mm (16.5")
Length	793 mm (31.2")	658 mm (25.9")
Weight	37,9 kg (83.6 lb)	37 kg (81.6 lb)

Hopper and Feeder Capacity

Envelope hopper	100 envelopes (80 g/m ² / 21 lb bond)
Document feeder tray 1 and 2	100 sheets (80 g/m ² / 21 lb bond) per feeder tray
BRE / Enclosure feeder tray 3	100 BRE's/Inserts

Document Specifications

Paper quality	minimum 60 g/m ² (16 lb bond) maximum 120 g/m ² (32 lb bond)
Paper size	Minimum width: 142 mm (5.6") Maximum width: 225 mm (8.9") Minimum length: 90 mm (3.5") Maximum length: 356 mm (14.0")
Folding capacity	V-fold - 5 sheets (max. 80 g/m ² / 21 lb bond) C-fold - 3 sheets (max. 80 g/m ² / 21 lb bond) Double V-fold - 2 sheets (max. 80 g/m ² / 21 lb bond)
Enclosure sizes	Standard BRE (Business Reply Envelopes) Maximum length: 158 mm (6.22")
Enclosure quality	BRE, minimum: 75 g/m ² (20 lb bond) BRE, maximum: 120 g/m ² (32 lb bond) Insert, minimum: 75 g/m ² (20 lb bond) Insert, maximum: 250 g/m ² (67 lb bond)

Envelope and Insert Specifications

Envelope quality	Minimum: 75 g/m ² (20 lb bond) Maximum: 120 g/m ² (32 lb bond)
------------------	---

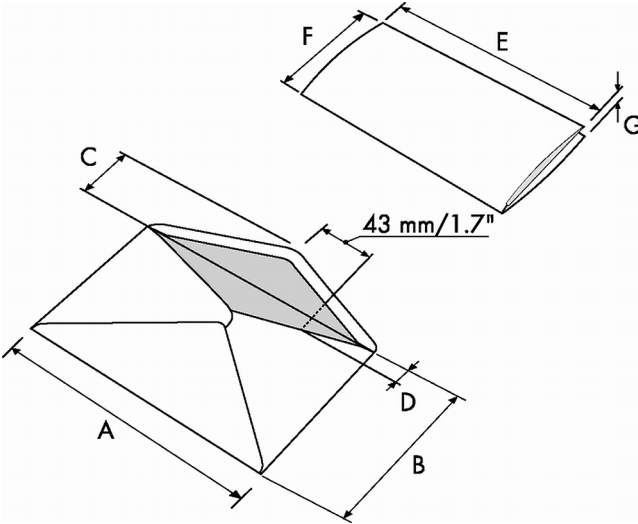

	A	B	C	D	E	F	G
Min. size	229 mm	105 mm	32 mm	10 mm	142 mm	90 mm*	70 g/m ²
Max. size	241 mm	162 mm	54 mm	35 mm	A-12 mm**	B-6 mm	1.5 mm
Min. size	9.0"	4.1"	1.3"	0.40"	5.6"	3.5"	
Max. size	9.5"	6.4"	2.1"	1.4"	A-0.47***	B-0.24"	0.06"

* In case of fold only (no insert): height > 120 mm / 4.7". If the Tri-Fold option is used: height = 99 mm / 3.9".

** When insert is more than 1 mm (0.04"): A-15 mm / A-0.6".

Remarks:

Maximum insert specifications are based on single sheets. When multiples are handled, more room inside the envelope is needed depending on the application. The specification

of the paper handling equipment is often wider than that of the envelopes and documents handled. The condition of material handled will limit the specified environmental conditions. We recommend that materials to be handled are stored at a temperature of 20°C (68°F) with a relative humidity factor of 50%. If difference in temperature occurs between store room and mailing area, the material has to be stored near the system at least 24 hours before use. Self-copying paper may cause rubber parts to wear quicker. The rubber used in this system has the best resistance to Wiggins Teape material.



9 Terminology

Terminology description

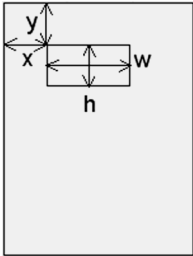
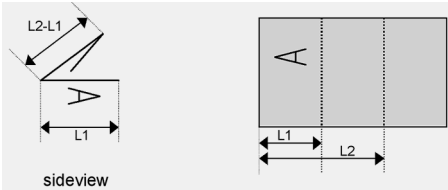
Term	Description
Address carrier	<p>The address carrier is the document that carries the address of the person for who the mail set is meant. The address carrier can consist of one or more sheets, from which at least the first sheet must contain the address. The address must remain visible while enclosures are added and the document set is folded. The fold type and selected envelope must ensure that the address is visible behind the window in the envelope. For personalized mailings there is always an address carrier present as long as envelope printing is not supported. Normally there is one address carrier.</p>
Address position	<p>Position of the address on the address carrier, measured from the upper left corner. The address position consists of a horizontal x coordinate, a vertical y coordinate, a horizontal width w and a vertical height h.</p> 
Business Reply Envelope (BRE)	<p>Envelope included in outgoing mail sets for addressee response purposes.</p>
C-fold	<p>Fold type in which a document set is folded twice in which the folded flaps are on top of each other. This fold is illustrated in the picture below. The position of both folds is adjustable.</p>  <p>sideview</p> <p>Synonym: Letter-fold.</p>

Daily Mail	Capability of an inserting system to manually insert mail sets one by one into the system, which are then inserted into an envelope. Optionally, depending on settings, additional enclosures can be added and the mail set can be folded. This function is intended for small amounts of mail that each can have a different build-up.
Document	A document is one of the components of a mail set. A document can consist of one or more sheets. Documents can be divided into address carriers and enclosures. For personalized mailings there is always one address carrier and an optional number of enclosures.
Document set	The document set is the physical collection of address carrier and enclosure(s) that is under production in the inserting system. The document set is completed during production and is to be inserted into the envelope. The number of enclosures can range from 0 to the limit opposed by the number of available feeders. Once the document set has been inserted into an envelope it is called mail set.
Double Feed Control (DFC)	Double Feed Control is the sensor that measures the thickness of a sheet to check if the inserting system does not accidentally take more sheets than intended. DFC sensors exist on feeders (double sheet detection). Currently DFCs on Neopost inserting systems perform relative measurements, which means that they need a cycle to 'learn' the thickness of a sheet. Also the length of the document is measured so partly overlapping sheets will be detected.

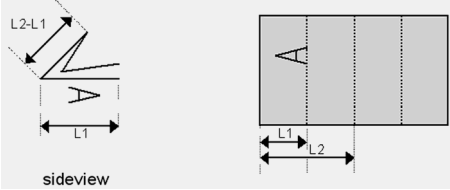
Term	Description
Double V-fold	<p>The double V-fold is a type of fold where the document is first folded halfway and the resulting folded set is again folded halfway. This fold is illustrated in the picture below. The position of both folds is adjustable.</p>  <p>The diagram consists of two parts. On the left, a 'sideview' shows a document being folded twice. The first fold is at a distance L_1 from the left edge. The second fold is at a distance $L_2 - L_1$ from the left edge of the first fold. On the right, a top view shows a document with two vertical fold lines. The first fold line is at a distance L_1 from the left edge, and the second fold line is at a distance L_2 from the left edge.</p> <p>Synonym: double parallel fold</p>
Envelope	<p>The envelope is the packaging of a mail set. Window envelopes are envelopes that have a transparent section through which the address on the address carrier can be read. Besides the normal top closing Window envelopes there are also bottom closing envelopes.</p>
Face Down	<p>Situation in which the front of a sheet is facing downwards when placed in a document feeder.</p>
Face down leading	<p>Situation in which the front of a sheet is facing downwards and the top of the sheet is closest to the separation unit in a document feeder.</p>
Face down trailing	<p>Situation in which the front of a sheet is facing downwards and the bottom of the sheet is closest to the separation unit in a document feeder.</p>
Face up	<p>Situation in which the front of a sheet is facing upwards when placed in a document feeder.</p>
Face up leading	<p>Situation in which the front of a sheet is facing upwards and the top of the sheet is closest to the separation unit in a document feeder.</p>
Face up trailing	<p>Situation in which the front of a sheet is facing upwards and the bottom of the sheet is closest to the separation unit in a document feeder.</p>
Feeder	<p>A feeder is a module for the input of documents to the inserting system. The feeder separates documents sheet by sheet from the stack of documents in the feeder tray.</p>
Feeder linking	<p>The ability to load two feeders with the same document type where the inserting system automatically switches to a second feeder when the first feeder is empty and vice versa. In the mean time the first feeder can be refilled, so the inserting system can keep running without having to stop for refilling the feeders.</p>
Feeder tray	<p>Part of the feeder that contains the stack of documents.</p>

Insert	<ul style="list-style-type: none">• An insert is the action of inserting a document set into an envelope.• For native English speaking customers an insert is also a short, not to be folded document, usually an enclosure.
Inserter	An inserter is the module where the document set is inserted into the envelope, the envelope is closed and if necessary sealed.



Term	Description
Inserting system	The system of all the modules that cooperate to perform the inserting function (accumulate document set, fold and insert) and have a single point of control.
Job	A job is an actually produced collection of mail sets based on a certain job definition at a certain point in time for a specific purpose. It consists of: <ul style="list-style-type: none">• The job definition used for the production• Information about the batch size
Job counter	The counter that registers the number of mail sets that is produced as part of a specific job.
Linking	See feeder linking.
Multifeed	The feature of an inserting system in which more than one sheet is taken from a feeder.
Operator	The person operating an inserting system.
Service engineer	Technical engineer whose task it is to resolve problems with systems in the field. Besides dealing with problems, service engineers are also responsible for preventive maintenance.
Supervisor	Person who is responsible for the technical state of the system. Normally a supervisor has access to programming functions, which are restricted for standard users.
Test run	A test run is intended to validate the settings of the inserting system: <ul style="list-style-type: none">• Inspect and adjust the stop position of the envelope.• Check the fold settings for one set.• Check whether the address is correctly positioned behind the envelope window.
Tray	Contains a stack of paper for a printer or inserter. This paper is supplied to the system for further processing.
V-fold	<p>A V-fold implies the document set is folded once. The fold position is adjustable. This fold is illustrated in the picture below:</p> <p>sideview</p> <p>Synonym: Single-fold</p>